

SERIES-L
LED URBAN LIGHT

PRODUCT CATALOG



7 YEAR
WARRANTY

SERIES-L
LED URBAN LIGHT

PRODUCT CATALOG

Light Distributions

★ Pendant Mounted | Side Entry Mounted | Suspended Mounted

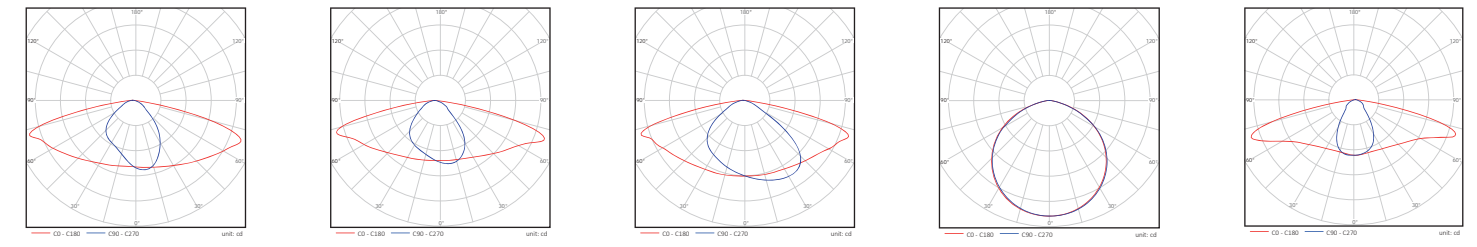

1M 2M 3M 5S 1M Symmetry

★ Post Top Mounted

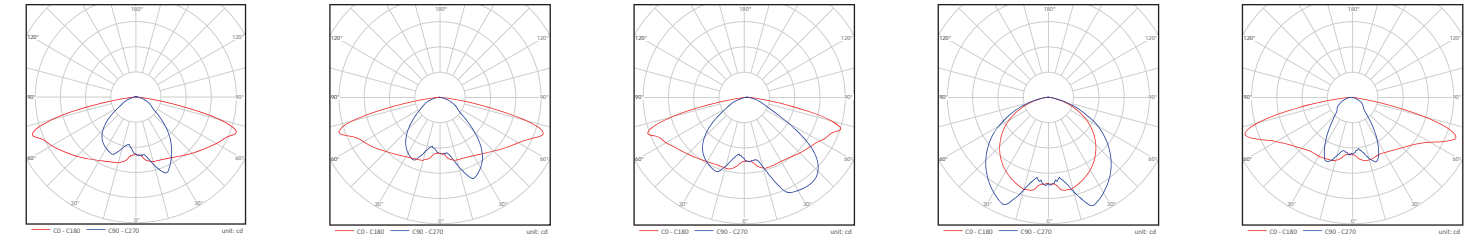

1M 2M 3M 5S 1M Symmetry

★ Internal Design

LED power supply
NON-DIMMABLE
 High-end MeanWell HLG Series LED driver, optimal stability, performance and lifespan.

INVENTRONICS
DIMMABLE
 High-end programmable Inventronics LED driver, integrate dimming function and 6KV /10KV surge protection. Provide excellent performance and lifespan.

High-efficacy LED light source
 Philips Lumileds 3030 2D
 Greater than 165lm/W high efficacy, illumination grade LED light source.

Philips Lumileds 5050
 Greater than 185lm/W high efficacy, illumination grade LED light source.

Imported breather
 Lamp breather ensures air balance inside and outside of the lamp, which improves lamp's service life.

Easy Maintenance
 Tool-less quick-release latches for speedy access.

Photocell available
 Lamp will Auto turn on and off according to lux difference.

Surge protection device(10KV)
 To provide more reliable guarantee for LED driver, extend the life of the product.

Power turn off protector (Only Post Top Mounted available)
 Under maintenance,when the fixtures are opened, the power will be cut off to protect personal safety.



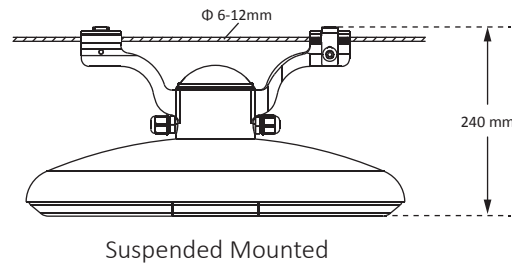
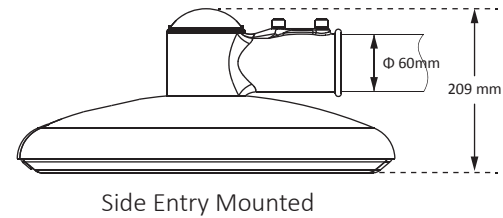
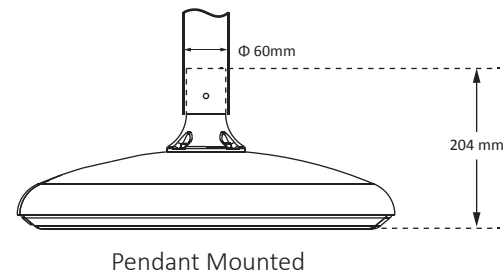
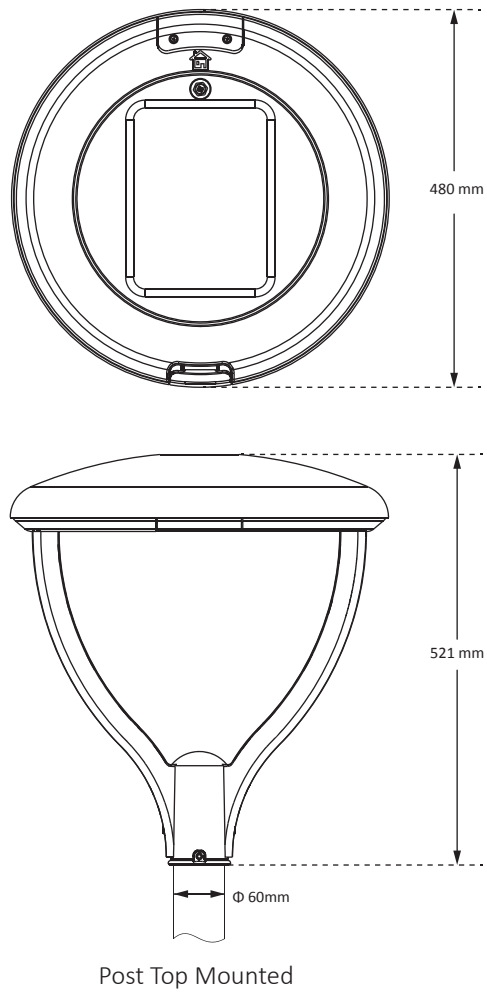

Packing Details

★ Luminaire [Side Entry Mounted and Suspended Mounted]

Model	Carton Size (mm)	N.W (kg)	G.W (kg)
ZGSM-LD27LM	495*495*170	7.4	9.1
ZGSM-LD37LM	495*495*170	7.6	9.3
ZGSM-LD56LM	495*495*170	7.7	9.4
ZGSM-LD70LM	495*495*170	7.8	9.5
ZGSM-LD90LM	495*495*170	7.9	9.6
ZGSM-LD120LM	495*495*170	7.9	9.6

Note: Above data of weight are all typical values.

★ Accessories [Side Entry Mounted and Suspended Mounted]

Mounted Type	Carton Size (mm)	N.W (kg)	G.W (kg)
Side Entry Mounted	235*125*105	1.0	1.5
Suspended Mounted	355*150*105	0.8	1.5

Note: Above data of weight are all typical values.

★ Luminaire and Accessories [Post Top Mounted and Pendant Mounted]

Model	Carton Size (mm)	Post Top Mounted		Pendant Mounted	
		N.W(kg)	G.W(kg)	N.W(kg)	G.W(kg)
ZGSM-LD27LM	495*495*170	8.7	10.4	7.6	9.3
ZGSM-LD37LM	495*495*170	8.9	10.6	7.8	9.5
ZGSM-LD56LM	495*495*170	9.0	10.7	7.9	9.6
ZGSM-LD70LM	495*495*170	9.1	10.8	8.0	9.7
ZGSM-LD90LM	495*495*170	9.2	10.9	8.1	9.8
ZGSM-LD120LM	495*495*170	9.2	10.9	8.1	9.8

Note: Above data of weight are all typical values.

Certification

Manufacturer
ISO9001, ISO14001
L Series [All Models]
CE, CB, ROHS, ENEC, LM80

Electrical & Photometric

A: Post Top Mounted

B: Pendant Mounted

C: Side Entry Mounted

D: Suspended Mounted

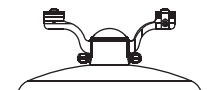
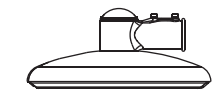
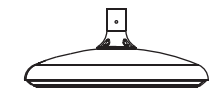
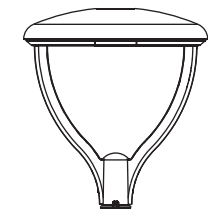

Order Reference
ZGSM-LD120LM [A]

★ 3030 Version

Series	Model	LED Qty/ Current	Power	Luminaire efficacy (+/- 5%)	Lumen Output (+/- 5%)	Input Voltage	LED Brand	Driver Brand	Light Distributions	CCT (K)	Surge Protection Device	Lifetime (h)
L	ZGSM-LD27LM □	72units/ 56mA	27W	130 lm /w*1	3510 lm	100-240V /277V AC 50 /60Hz	Philips Lumileds 3030 2D	MeanWell Inventronics	1M, 2M, 3M, 5S 1M Symmetry*2	3000*3 4000 5000 5700	10KV	>100,000 (L70)
	ZGSM-LD37LM □	96units/ 59mA	37W	130 lm /w*1	4810 lm							
	ZGSM-LD56LM □	120units/ 70mA	56W	130 lm /w*1	7280 lm							
	ZGSM-LD70LM □	144units/ 78mA	70W	130 lm /w*1	9100 lm							
	ZGSM-LD90LM □	168units/ 86mA	90W	130 lm /w*1	11700 lm							
	ZGSM-LD120LM □	168units/ 110mA	120W	130 lm /w*1	15600 lm							

*1 Luminous Efficacy of post top mounted is 10% lower than other installation methods.

*2 Luminous Efficacy of 5S is 10% higher than other Light Distributions.

*3 Luminous Efficacy of 3000K is 5% lower than other CCTs.

★ 5050 Version

Series	Model	LED Qty/ Current	Power	Luminaire efficacy (+/- 5%)	Lumen Output (+/- 5%)	Input Voltage	LED Brand	Driver Brand	Light Distributions	CCT (K)	Surge Protection Device	Lifetime (h)
L	ZGSM-LD27LM □	36units/ 28mA	27W	140 lm /w*1	3780 lm	100-240V /277V AC 50 /60Hz	Philips Lumileds 5050	MeanWell Inventronics	1M, 2M, 3M, 5S 1M Symmetry*2	3000*3 4000 5000 5700	10KV	>100,000 (L70)
	ZGSM-LD37LM □	48units/ 29mA	37W	140 lm /w*1	5180 lm							
	ZGSM-LD56LM □	60units/ 35mA	56W	140 lm /w*1	7840 lm							
	ZGSM-LD70LM □	72units/ 40mA	70W	140 lm /w*1	9800 lm							
	ZGSM-LD90LM □	84units/ 42mA	90W	140 lm /w*1	12600 lm							
	ZGSM-LD120LM □	84units/ 56mA	120W	140 lm /w*1	16800 lm							

*1 Luminous Efficacy of post top mounted is 10% lower than other installation methods.

*2 Luminous Efficacy of 5S is 10% higher than other Light Distributions.

*3 Luminous Efficacy of 3000K is 5% lower than other CCTs.

Mechanical

Model	Working Environment	Storage Temperature	Rating	CRI	Power Factor	Power Efficiency	Material	Pole/ Rope Diameter (mm)
ZGSM-LD27LM	-40 °C ~ +50 °C 10% ~ 90%RH	-40 °C ~ +50 °C	Class I IP66 IK08	>70	>0.95	>90%	Housing: Die-cast aluminum Lens: Tempered glass and PC	Side Entry Mounted: Φ 60mm(External diameter of the pole) Suspended Mounted: Φ 6-12mm(External diameter of the rope) Post Top Mounted: Φ 60mm(External diameter of the pole) Pendant Mounted: Φ 60mm(Internal diameter of the pole)
ZGSM-LD37LM								
ZGSM-LD56LM								
ZGSM-LD70LM								
ZGSM-LD90LM								
ZGSM-LD120LM								

Note: Above data of weight are all typical values.